



Bobcat[®]

One Tough Animal.

COMPACT TRACK LOADERS

T66, T76, T86

R-Series

🌐 Europe



INTRODUCTION

ONE TOUGH ANIMAL



BOBCAT'S HISTORY

In 1958, Melroe Manufacturing Company introduced a compact front-end loader that evolved quickly into the M400, the world's first true skid steer loader. The company soon adopted what became the world-famous 'Bobcat' brand – and its success paved the way for the global compact equipment industry we know today.

CONTINUOUS INNOVATION

New technologies and machines are rigorously tested in our innovation facilities to take on the toughest jobs.



BOBCAT TODAY

Since introducing our first compact track loader in 1999, the new category quickly gained popularity thanks to Bobcat's decades of experience building compact loaders to the highest standards.



OUR MISSION

We empower operators to accomplish more, while working in the toughest conditions and tightest situations. When our customers have the will, we provide the way.

BUILT FOR ALL CONDITIONS

TOUGHNESS MEETS INNOVATION

Using decades of experience developing the toughest loader on the planet, we added a host of improvements and smart technology to increase durability, boost performance, and bring first-class comfort to the all-new R-Series loaders.



LED lights with optional Premium LED with corner view

Optional side LED lights

Steel casting design for greater visibility without compromising durability

Clear-view cab option for advanced visibility

Auto Ride Control option provides dampening effect for lift arms

Cast steel arms for better visibility while keeping the outstanding durability

Improved cooling for improved performance and reliability

Compatible with a full range of over 100 attachments thanks to standardized Bob-Tach™ technology

Attachments are automatically leveled when moving up or down thanks to dual bucket positioning

5-link torsion suspension for smooth all-terrain ride

One-piece cast upgraded Bob-Tach™ with integrated debris shedding

5-block coupler with Super Flow for up to 20% boost in productivity (only for T86)



STABLE AND STRONG
Outstanding lift capacity with high pushing and breakout forces, complemented by excellent machine stability.



BUILT TOUGH
One-piece cast steel loader arms and upgraded Bob-Tach™ with integrated debris shedding are designed for the most challenging conditions.



FIRST CLASS COMFORT
5-link torsion suspension provides a smooth ride, while connectivity options and soundproof cab make staying in touch easy.



IMPROVED VISIBILITY
New cab construction is optimized for maximum visibility, further expandable by clear-view cab or rear-view camera options.

POWER WHERE YOU NEED IT

▶ INDUSTRY-UNIQUE PERFORMANCE

The Super Flow and 5-block coupler – exclusive to the T86 – take auxiliary flow to 159 l/min and offer greater productivity and +20% efficiency with advanced attachments.



▶ TRULY ALL-TERRAIN

The R-Series' weight distribution and optimized footprint allow travel and work where other machines cannot go. You can be gentle when required and climb steep inclines.



OUTSTANDING PERFORMANCE



▶ IMPROVED COOLING

The R-Series' smart cooling system has been completely redesigned for optimal operation and uptime. The fan is almost 50% bigger and comes with a reversible option, increasing productivity in dirty conditions.



▶ INCREASED LIFTING CAPABILITIES

With more surface area in contact with the ground and a perfect balance between weight and horsepower, the R-Series features outstanding stability and enough lift capacity for any job site.

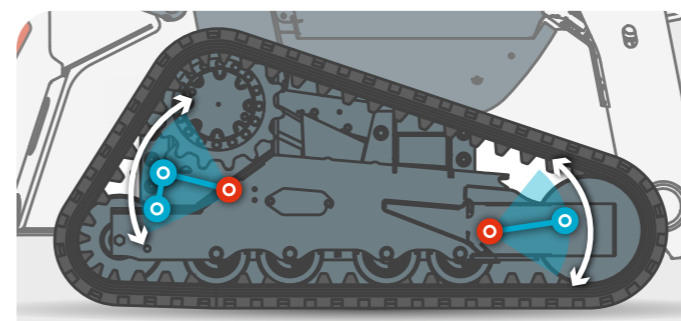

▶ 5-LINK TORSION SUSPENSION

The R-Series undercarriage provides more stability when lifting or grading as well as a smoother ride, thanks to its 5-link torsion suspension. This simple and durable design also reduces vibration to further improve component life.

STEP INSIDE



► CLEAR-VIEW CAB

The optional clear side enclosure adds thick polycarbonate side windows with abrasion-resistant coating – maximizing your visibility and ensuring the best possible view of tracks and corners.

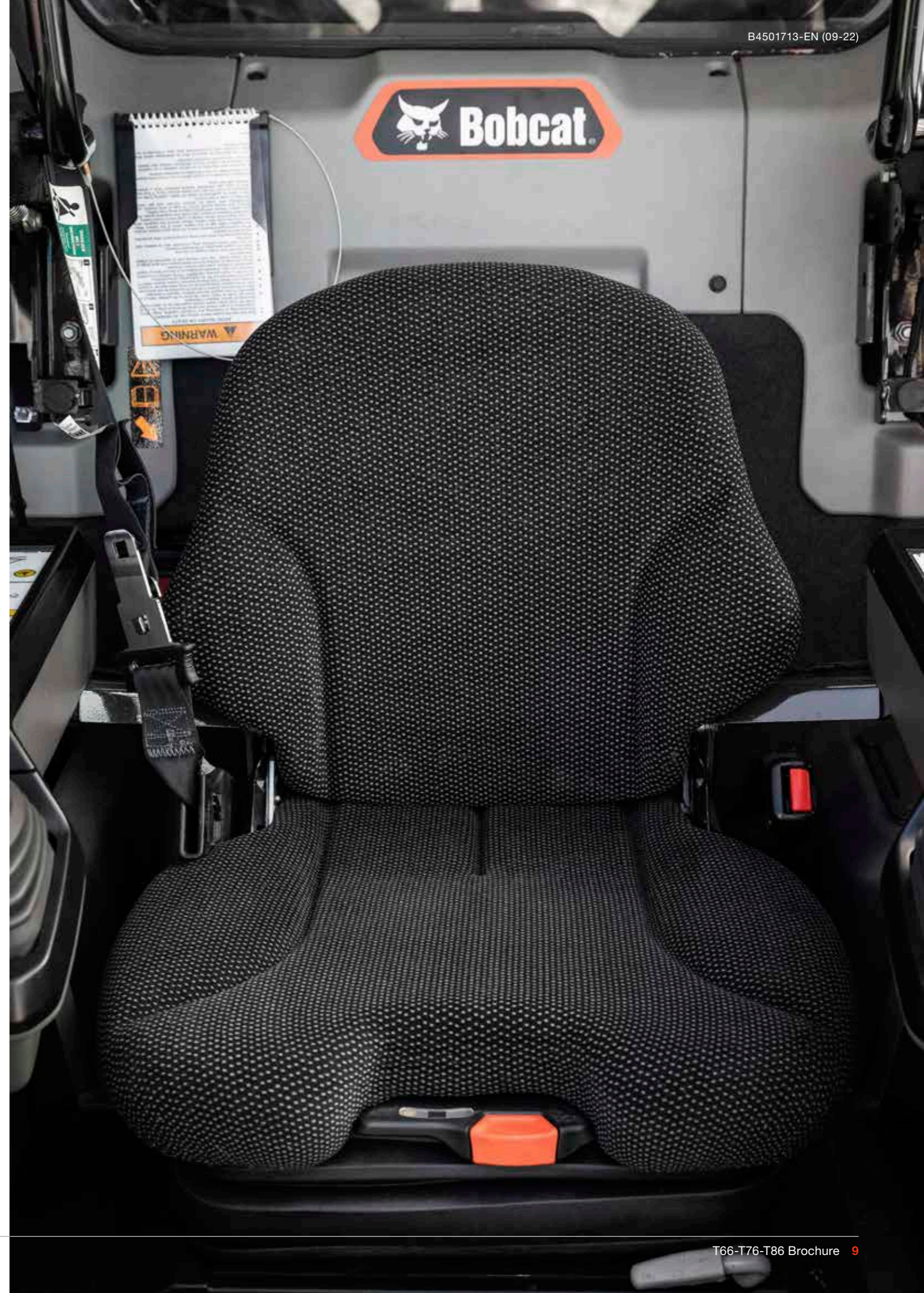

► INTUITIVE TOUCH CONTROLS



Take control of all settings with the optional glove-sensitive 7-inch display. New display is waterproof and scratch resistant.

► ADVANCED CONNECTIVITY



Connect your phone – thanks to the integrated Bluetooth – and enhance your comfort during calls or play your favorite music.

► PERFECT SEAT



Comfortable suspension seat as standard, and optional cloth heated air-ride seat, for maximum comfort all day – and all year – long.

BUILT TO LAST

▶ OUTSTANDING UPTIME

The R-series has been developed with a special focus on durability and uptime – featuring many small improvements that, together, help minimize maintenance and protect your machine: self-diagnostics, machine shutdown protection, battery run-down protection, cold weather protection, improved lubrication and access to greasing points, improved protection of hoses, and more. Additionally, R-Series track loaders feature long-lasting tracks and a reliable undercarriage, which further increase uptime and give you added peace of mind.

▶ EXTENDED SERVICE INTERVALS

R-Series loaders feature a new fuel filter with more than double the media surface area, protecting the system even better and greatly extending the life of the filter. The improved engine design also significantly lengthens the air filter's life. This and other features allow you to improve efficiency and reduce operating costs, thanks to extended service intervals. Bobcat recommends first service after 500 hours of operation.



▶ MACHINE IQ

BOBCAT® Machine IQ Wireless Communications enhances the support for your Bobcat machine.

- Durable built-in monitoring electronics
- Data is available to our machine monitoring specialist
- Maintenance is optimized for your business
- Data-driven services maximize uptime

▶ STANDARD WARRANTY

Bobcat develops every machine to the highest standards of quality and durability. That's why our standard warranty provides 24 months or 2 000 operating hours (whichever occurs first) of coverage.

THERE'S NO TIME FOR DOWNTIME. STAND UP TO THE HARSHTEST CONDITIONS. DAY AFTER DAY.



▶ PROTECTION PLUS EXTENDED WARRANTY

Enjoy total peace of mind with Protection Plus® extended warranty. Providing the same level of protection as the standard warranty, Protection Plus also reflects different customer needs and expectations by offering a choice of durations and annual operating hours. According to your needs, you can benefit from the coverage for up to 5 years or 6 000 engine hours. And Protection Plus is transferrable – so it will likely increase your machine's resale value.



▶ BOBCARE

A long-running machine starts with proper planned maintenance, which helps protect against repair costs and unplanned failures when you're counting on your machine to work.

- Avoid risk by preventing major repairs and complete failures.
- Accomplish more by reducing downtime and increasing your productivity and profitability.

T66

► COMPACT YET POWERFUL

Equipped with the same dependable engine as its bigger brother, the T66 packs a surprising punch in its compact footprint and a rated operating capacity of 1 086 kg.



T76

► TRULY MULTI-PURPOSE

The T76's great hydraulic performance guarantees productivity and greater rated operating capacity than lighter machines. Adapt to any situation – and tackle anything the job site demands – with impressive versatility.



CHOOSE YOUR ANIMAL

T86

► MUSCLES FOR EVERY JOB

A powerful yet agile machine, the T86 is our first track loader to boast over 100 horsepower (105 HP). It offers superior performance for even the most demanding jobs with a 1 780 kg rated operating capacity, 3-tonne tipping load, and the Super Flow.



STANDARD EQUIPMENT & OPTIONS

	T66	T76	T86
CAB			
3-point seat belt	✓	✓	✓
5" Deluxe instrumentation (radio ready)	✓	✓	✓
7" touch display	•	•	•
Adjustable suspension seat	✓	✓	✓
Heated cloth air ride seat with 3-point seat belt	•	•	•
Auto HVAC	•	•	•
Clear-view cab*	•	•	•
Deluxe pressurized cab* with HVAC	✓	✓	✓
Fire extinguisher kit	•	•	•
FOPS kit*	•	•	•
Key start	✓	✓	✓
Keyless kit	•	•	•
Lexan rear window kit	•	•	•
Radio	•	•	•
Seat bar	✓	✓	✓
Selectable Joystick Controls (SJC)	✓	✓	✓
Special applications front door kit	•	•	•
LIGHTS & BEACON			
4-way flasher kit	•	•	•
Beacon	•	•	•
LED side lighting kit	•	•	•
LED working lights front and rear	✓	✓	✓
Premium LED lights (with corner view)	•	•	•
Headlight guard kit	•	•	•
Tail light guard kit	•	•	•
Strobe	•	•	•
TRACKS			
400 mm multi bar lug tracks	•	–	–
400 mm wide rubber tracks	✓	–	–
450 mm multi bar lug tracks	–	•	•
450 mm wide rubber tracks	–	✓	✓
PERFORMANCE			
14-pin attachment control kit	✓	✓	✓
200 lbs (74.4 kg) counterweight kit	•	•	•
300 lbs (111.9 kg) counterweight kit	•	•	•
Auto Ride Control	•	•	•
Auxiliary hydraulics: variable flow/maximum flow	✓	✓	✓
Bob-Tach™ attachment system	✓	✓	✓
Bobcat Interlock Control System (BICS)	✓	✓	✓
Dual direction bucket positioning (including ON/OFF switch)	✓	✓	✓
Engine block heater kit	•	•	•
Engine/hydraulics system shutdown	✓	✓	✓
Five coupler auxiliary block	–	–	•
High flow hydraulics	✓	✓	✓
Super Flow hydraulics	–	–	✓
Lift arm support	✓	✓	✓
Power Bob-Tach™	•	•	✓
Rear auxiliary hydraulic kit	•	•	•
Reversible fan	•	•	•
Spark arrestor muffler	✓	✓	✓
2-speed travel	✓	✓	✓
MISCELLANEOUS			
Backup alarm	✓	✓	✓
Debris seal Kit	•	•	•
4-point lift kit	•	•	•
Horn	✓	✓	✓
Machine IQ (telematics)	✓	✓	✓
Operating manual	✓	✓	✓
Parking brake	✓	✓	✓
Reversing camera	•	•	✓
Road kit	•	•	•
Single-point lift kit	•	•	•
Warranty: 24 months or 2 000 hours (whichever occurs first)	✓	✓	✓

* Roll Over Protective Structure (ROPS) – meets requirements of SAE-J1040 and ISO 3471; Falling Object Protective Structure (FOPS) – meets requirements of SAE-J1043 and ISO 3449, Level I

• = option ✓ = standard – = not available or not compatible

PERSONALIZE YOUR MACHINE

Sometimes, we all want to add a specific functionality or a personal touch to the machine. Choose from a list of comprehensive options and customize your track loader to your heart's content!



7" touch display

Auto HVAC

Auto Ride Control

LED side lighting kit

Power Bob-Tach™

Premium LED lights
(with corner view)

Clear view cab

Headlight guard kit

Lexan rear window kit

Reversible fan

Reversing camera

Tail light guard kit



5-link torsion suspension system

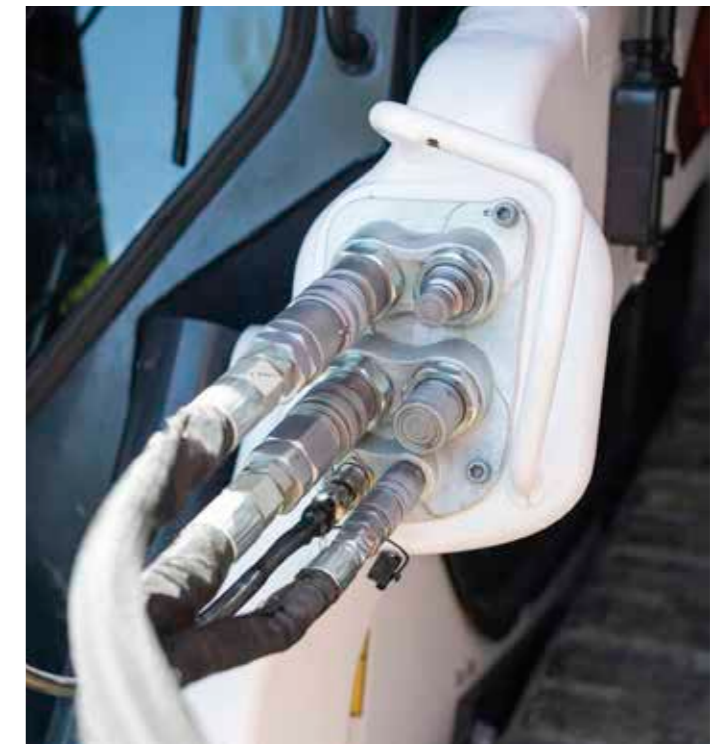

5-block coupler for Super Flow

MULTI-TOOL CARRIER

BOBCAT ATTACHMENTS

Get more versatility and efficiency with Bobcat attachments.

- The largest choice of attachments in the industry.
- Match performance to your Bobcat machine.
- Work harder with stronger components and construction.
- Rest easy with the 12-month warranty on every genuine Bobcat attachment.

POWERFUL ENGINE & HYDRAULIC OUTPUT

Bobcat's Super Flow feature delivers powerful hydraulic performance on several advanced attachments, with greater compatibility available soon.

Actual attachment compatibility may vary based on different machine configurations. Contact your dealer for actual attachment compatibility.



Angle brooms

Box blades



Laser graders

Brush saws



Wheel saw



Concrete mixers

Drop hammers



Grapplers

Landplanes



Forestry cutter



Landscape rakes

Tillers



Pallet forks

Root grapples

ATTACHMENTS	T66	T76	T86
Angle brooms	•	•	–
Augers	•	•	•
Bale forks	•	•	–
Box blades	–	•	•
Breakers	•	•	•
Brushcat™ rotary cutters	•	•	•
Brush saws	•	•	•
Combination buckets	•	•	•
Concrete mixers	•	•	•
Construction / industrial buckets	•	•	•
Diggers	•	•	–
Dozer blades	•	•	•
Drop hammers	–	•	•
Dumping hoppers	•	•	•
Fertilizer and grain buckets	•	•	–
Flail cutters	•	•	•
Forestry cutters	–	–	•
General purpose (GP) bucket	•	•	–
Graders	•	•	•
Grapples, industrial	•	•	•
Landplanes	•	•	•
Landscape rakes	•	•	•
Laser equipment	•	•	•
Low profile buckets	•	•	•
Mixing buckets		•	•
Miscellaneous	–	–	•
Mowers	•	•	–
Pallet forks	•	•	–
Pallet fork accessories	–	–	•
Pallet forks, hydraulic	–	–	•

ATTACHMENTS	T66	T76	T86
Planer accessories	–	–	•
Planers	–	–	•
Rear stabilizers	–	–	•
Remote control	•	•	•
Root grapples	•	•	•
Rotary grinders	–	–	•
Sand cleaners	–	–	•
Scarifiers	•	•	•
Scrapers	•	•	•
Seeders	–	–	•
Skeleton buckets	•	•	•
Snow & light material buckets	•	•	–
Snow blades, pushers, V-blades	•	•	•
Sod layers	•	•	•
Soil conditioners	•	•	•
Spreaders	•	•	•
Steel tracks	–	•	–
Stump grinders	–	•	•
Sweepers	•	•	•
Tillers	•	•	•
Tree transplanters	–	•	•
Trench compactors	–	•	•
Trenchers	–	–	•
Utility forks	•	•	•
Utility frames	–	–	•
Vibratory rollers	•	•	•
Wheel saws	–	–	•
Whisker brooms	•	•	–
Wood chippers	•	•	•

• = compatible – = not compatible



Breakers

Planer



Snow blades

Tree transplanters



Stump grinders

Scrapers

SPECIFICATIONS

SPECIFICATIONS			
	T66	T76	T86
MACHINE RATING			
Tipping load (ISO 14397-1)	3 175 kg	4 050 kg	5 087 kg
Rated operating capacity (ISO 14397-1)	1 115 kg	1 426 kg	1 780 kg
Pump capacity std flow (at pump RPM)	66.5 l/min	88.1 l/min	87.1 l/min
Pump capacity high flow (at pump RPM)	101.8 l/min	114.7 l/min	138.5 l/min
Pump capacity Super Flow (at pump RPM)	-		159 l/min
System relief at quick couplers	23.8 - 24.5 MPa	23.8 - 24.5 MPa	23.8 - 24.5 MPa
Travel speed (low)	10.4 km/h	14.8 km/h	8.7 km/h
Travel speed (high)	16.4 km/h	17.2 km/h	16.7 km/h
Lift arm path	vertical		
DIMENSIONS			
Length with standard bucket	3 427 mm	3 737 mm	3 900 mm
Width with standard bucket	1 880 mm	2 032 mm	2 032 mm
Height with operator cab	2 045 mm	2 079 mm	2 111 mm
Height to bucket hinge pin	3 048 mm	3 259 mm	3 353 mm
Ground contact length	1 378 mm	1 505 mm	1 683 mm
ENGINE			
Make / Model	Bobcat 2.4i, 97/68 EC Stage V		D34 BSH SV, 97/68 EC Stage V
Fuel	Diesel		
Cooling	Liquid		
Power at 2 600 RPM (ISO 14396)	54.5 kW		78.7 kW
Torque at 1 800 RPM (ISO 14396)	283.9 Nm		409 Nm
Number of cylinders	4		
Displacement	2 400 cm ³		3 409 cm ³
Fuel tank capacity	107.1 l	120 l	120 l
WEIGHTS			
Operating weight*	4 296 kg	5 051 kg	5 643 kg
Shipping weight	3 712 kg	4 394 kg	5 228 kg
ENVIRONMENTAL			
Operator LpA (98/37 & 474-1)	80 dB(A)		78 dB(A)
Noise level LWA (EU Directive 2000/14/EC)	103 dB(A)		103 dB(A)
Whole body vibration (ISO 2631-1) high speed	0.8 ms ⁻²		0.36 ms ⁻²
Hand-arm vibration (ISO 5349-1) high speed	2.8 ms ⁻²		1.84 ms ⁻²
FORCES			
Lift breakout force	2 269 daN	3 544 daN	
Tilt breakout force	2 179 daN	2 871 daN	
Push force	3 573 daN	3 544 daN	
CYCLE TIMES			
Raise lift arms	4 s	3.9 s	
Lower lift arms	2.8 s	2.6 s	
Bucket rollback	1.7 s		
Bucket dump	2.5 s	2.3 s	

* Base machine with bucket, operator and full fuel tank

Certain specification(s) are based on engineering calculations and are not actual measurements. Specification(s) are provided for comparison purposes only and are subject to change without notice. Specification(s) for your individual Bobcat equipment will vary based on normal variations in design, manufacturing, operating conditions, and other factors. Pictures of Bobcat units may show other than standard equipment.

SPECIFICATIONS

DIMENSIONS

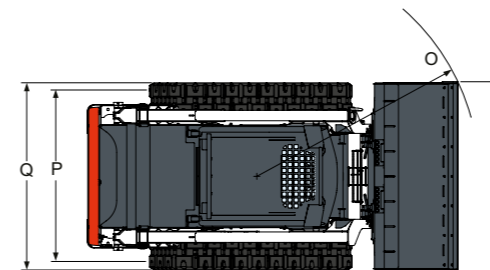
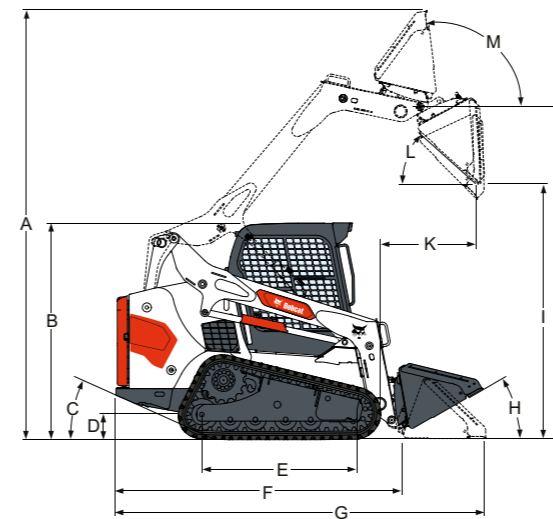

	T66	T76	T86
A Operating height	3 910	4 252	4 345
B Height with operator cab	2 045	2 079	2 111
C Angle of departure	25°	27°	30°
D Ground clearance	214	235	236
E Ground contact length	1 378	1 505	1 683
F Length without attachment	2 718	2 894	3 059
G Length with standard bucket	3 427	3 737	3 900
H Rollback at ground position	30°	30°	30°
I Dump height with standard bucket	2 396	2 526	2 586
J Height to bucket hinge pin	3 048	3 259	3 353
K Dump reach at maximum height	933	1 014	976
L Dump angle at maximum height	37°	37°	40°
M Rollback fully raised at maximum height	94°	94°	93°
N Width over standard bucket	1 880	2 032	2 032
O Turning radius with standard bucket	2 104	2 301	2 255
P Track, 450 mm tracks	1 382	1 531	1 856
Q Width over tracks, 450 mm tracks	1 782	1 981	1 981

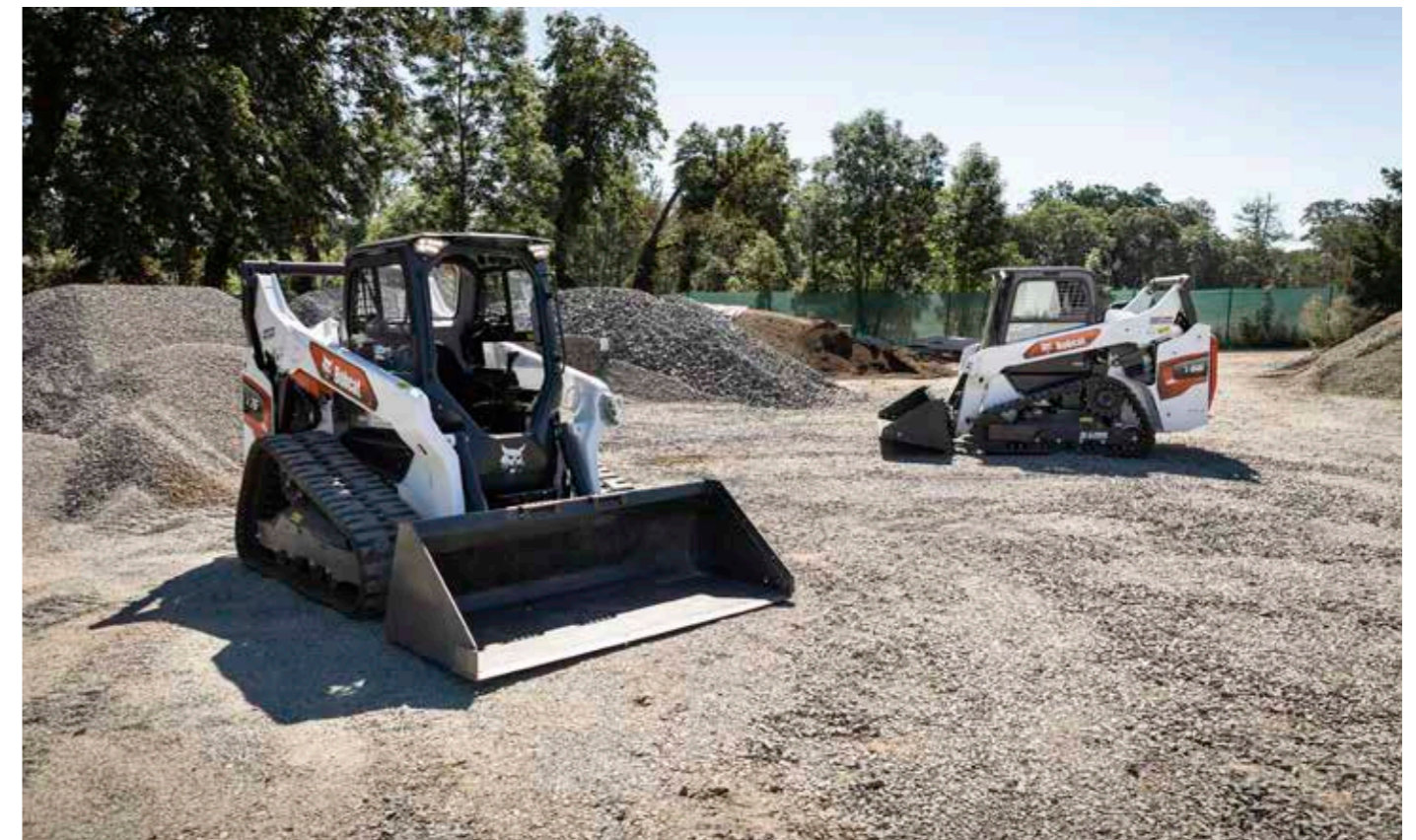

FINANCING OPTIONS

24, 36, OR 48 MONTH FINANCING*

Take advantage of 24, 36 or 48 month financing programs starting from **0% interest** and improve your cashflow. Ask your dealer for the financing offers available.

100 MACHINES / 150 ATTACHMENT FAMILIES / 1 TOUGH ANIMAL



**SKID STEER
LOADERS**



**COMPACT TRACK
LOADERS**

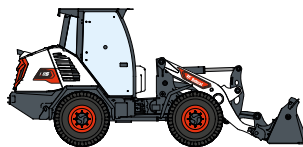

**COMPACT WHEEL
LOADERS**



**SMALL ARTICULATED
LOADERS**

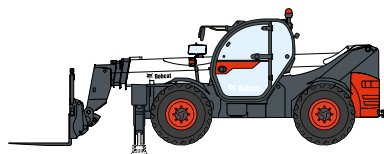

TELEHANDLERS

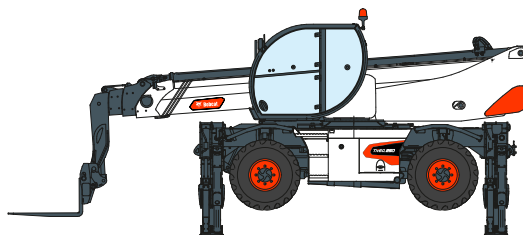

ROTARY TELEHANDLERS



**LIGHT COMPACTION
EQUIPMENT**



**MINI TRACK
LOADER**



COMPACT EXCAVATORS

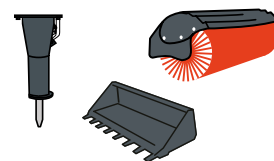

ATTACHMENTS

DOOSAN

www.bobcat.com

Bobcat is a Doosan Company. Doosan is a global leader in construction equipment, power & water solutions, engines, and engineering proudly serving customers and communities for more than a century. | Bobcat and the Bobcat logo are registered trademarks of Bobcat Company in the United States and various other countries. ©2022 Bobcat Company. All Rights Reserved.

©2022 BOBCAT B4501713-EN (09-22)



*Financing options may vary by country and dealer. Always ask your dealer about currently available financing options. Terms and conditions may apply.

Doosan Bobcat EMEA, U Kodelky 1810, 263 12 Dobříš, Czech Republic